



Application Notes:

101
102
104
007

Balanced-Force Design

Hermetically sealed

Contact arrangement **3 PDT**

Designed to the performance standards of **MIL-PRF-6106**

PRINCIPLE TECHNICAL CHARACTERISTICS

Contacts rated at 28 Vdc and
115 Vac, 400 Hz, 1 Ø and
115/200 Vac, 400Hz, 3 Ø

Weight See Mounting

Special units available upon request, including models with auxiliary contacts.

CONTACT ELECTRICAL CHARACTERISTICS

Contact rating per pole and load type	Load current in Amps					
	28 Vdc	115 Vac 400 Hz	115/200 Vac, 400 Hz, 3Ø	28 Vdc [4]	28 Vdc [9]	DELTA 115/200 Vac 60 Hz
Resistive	50	120	120	120	200	60
Inductive [1]	30	120	120	80	-	60
Motor	30	80	80	60	-	60
Load transfer, resistive [6]	-	-	120	-	-	-

COIL CHARACTERISTICS (Vdc)

CODE	A	B	C	F Vac 400 Hz	N [5]	Y [7]	YN [5]
Nominal operating voltage	28	12	6	115	28	28	28
Maximum operating voltage	29	14.5	7.3	124	29	29	29
Set & reset voltage, maximum							
- Nominal	18	9	4.5	90	18	18	18
- High temp test	20	10	5	95	20	20	20
- Continuous current test	22.5	11	5.6	100	22.5	22.5	22.5
Drop-out voltage, maximum	N/A	N/A	N/A	90	N/A	N/A	N/A
Coil resistance in Ohms \pm 20% at +25 °C	163	40	10	-	163	-	-
Coil current Amp max. @ Nom. Volt. and +25 °C	-	-	-	0.085	-	-	-

GENERAL CHARACTERISTICS

Temperature range	-55°C to +71°C
Minimum operating cycles (life) at rated load	50,000
Minimum operating cycles (life) at 25% rated load	100,000
Dielectric strength at sea level	
- All circuits to ground and circuit to circuit	1,500 Vrms
- Coil to ground and Aux.contacts	1,250 Vrms
Dielectric strength at altitude: 70,000 feet	500 Vrms
Insulation resistance	
- Initial (500 Vdc)	100 M Ω min
- After environmental tests (500 Vdc)	50 M Ω min
Sinusoidal vibration (55 to 500 Hz)	10 G
Shock (10-12 ms duration)	15 G
Maximum contact opening time under vibration and shock	10 μ s
Operate time at nominal voltage (Including bounce)	60 ms max 25 ms max (Economizer coil)
Contact bounce at nominal Voltage	4 ms max
Overload	800 Amps
Rupture	1,000 Amps
Altitude	50,000 Feet

Dimensions in inches
 Tolerances, unless otherwise specified,
 XX ±.03
 XXX ±.010

CONFIGURATION STYLES

MOUNTING STYLE A

WEIGHT: 2 LB MAXIMUM
 WEIGHT IS DEPENDENT UPON CONFIGURATION REQUIRED.
 PLEASE CONSULT FACTORY.

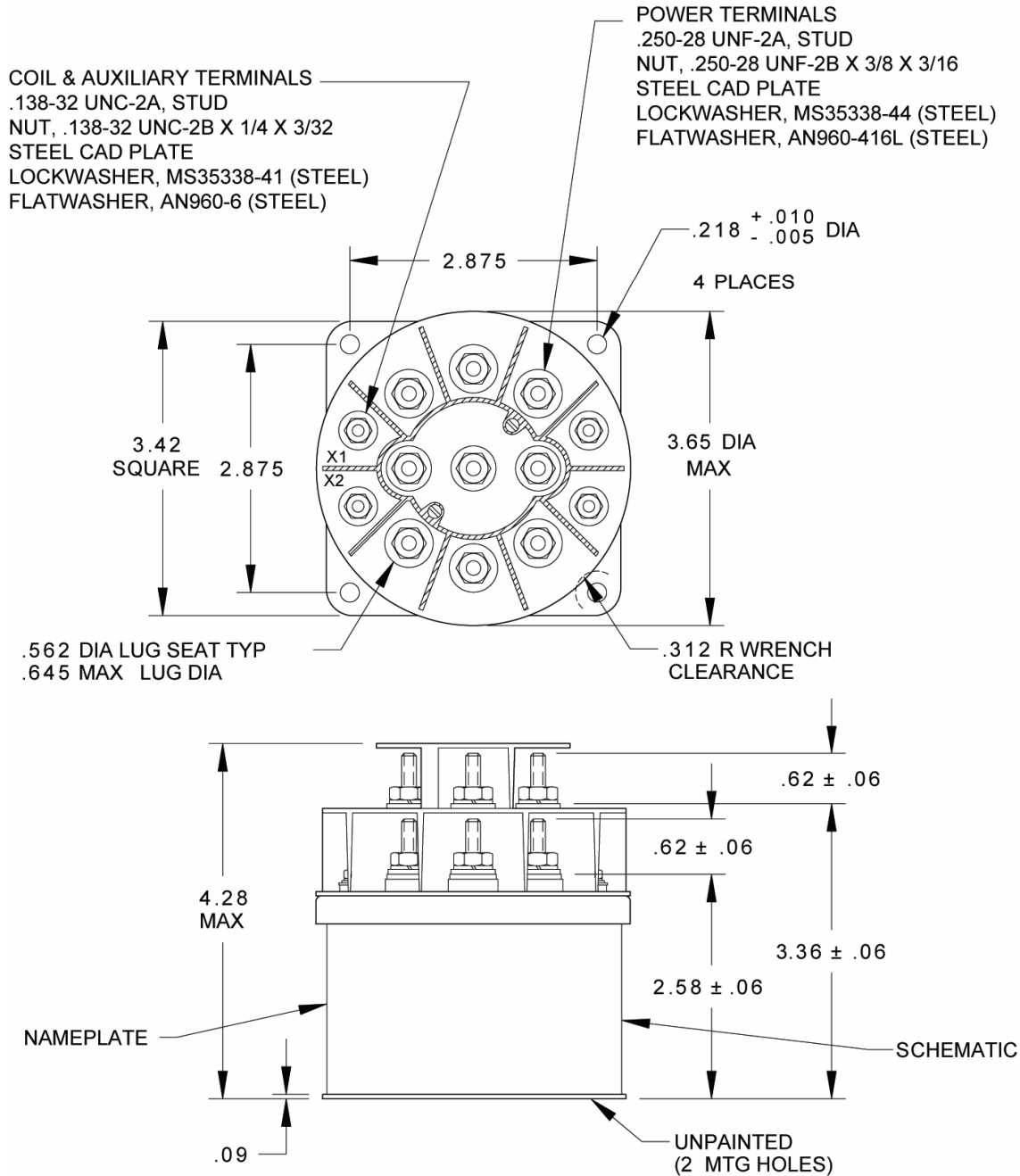

Dimensions in inches
 Tolerances, unless otherwise specified,
 XX ±.03
 XXX ±.010

CONFIGURATION STYLES

MOUNTING STYLE B

WEIGHT: 2 LB 12 OZ MAXIMUM
 WEIGHT IS DEPENDENT UPON CONFIGURATION REQUIRED.
 PLEASE CONSULT FACTORY.

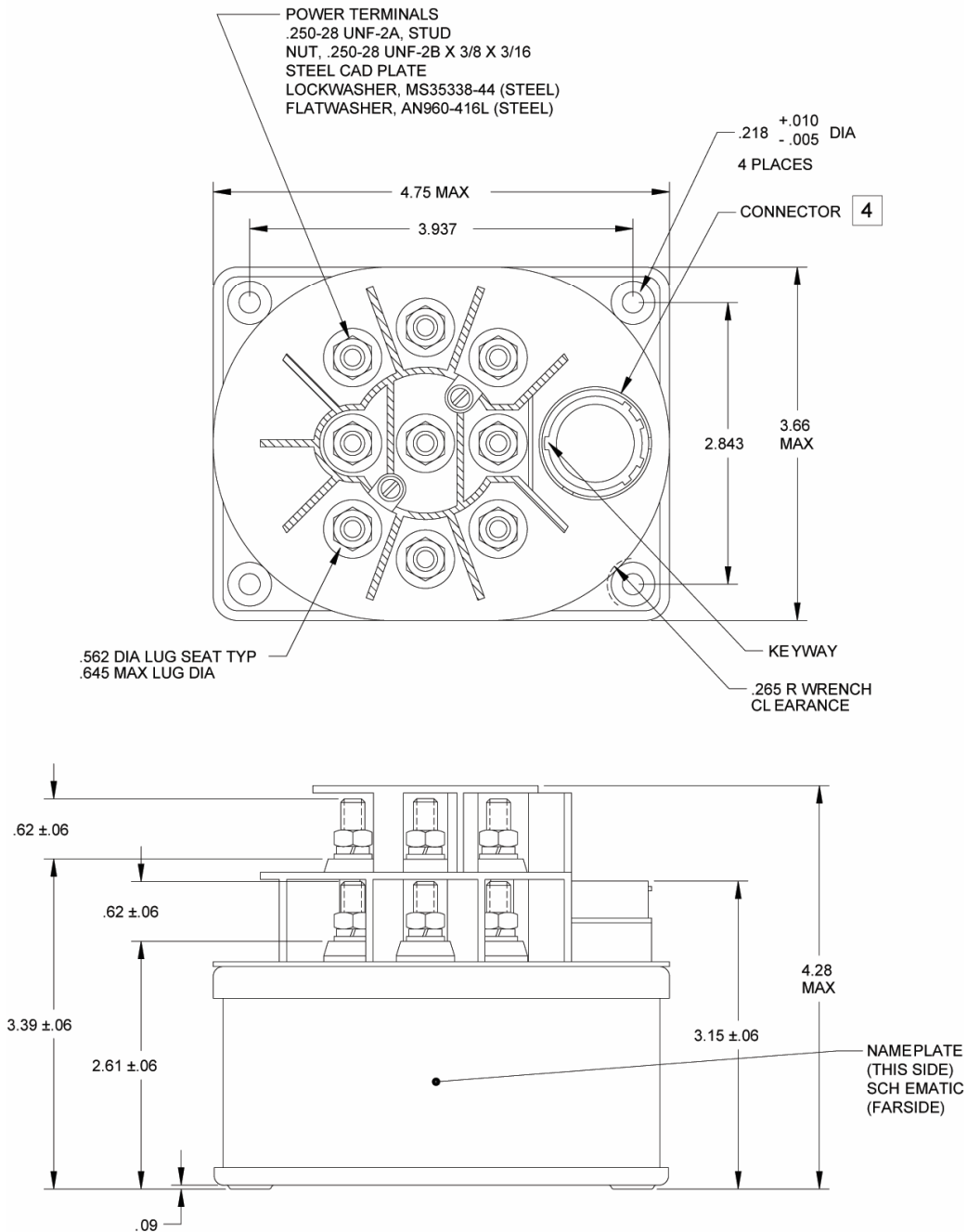

Dimensions in inches
 Tolerances, unless otherwise specified,
 XX ±.03
 XXX ±.010

CONFIGURATION STYLES

MOUNTING STYLE K

WEIGHT: 2 LB 13 OZ MAXIMUM

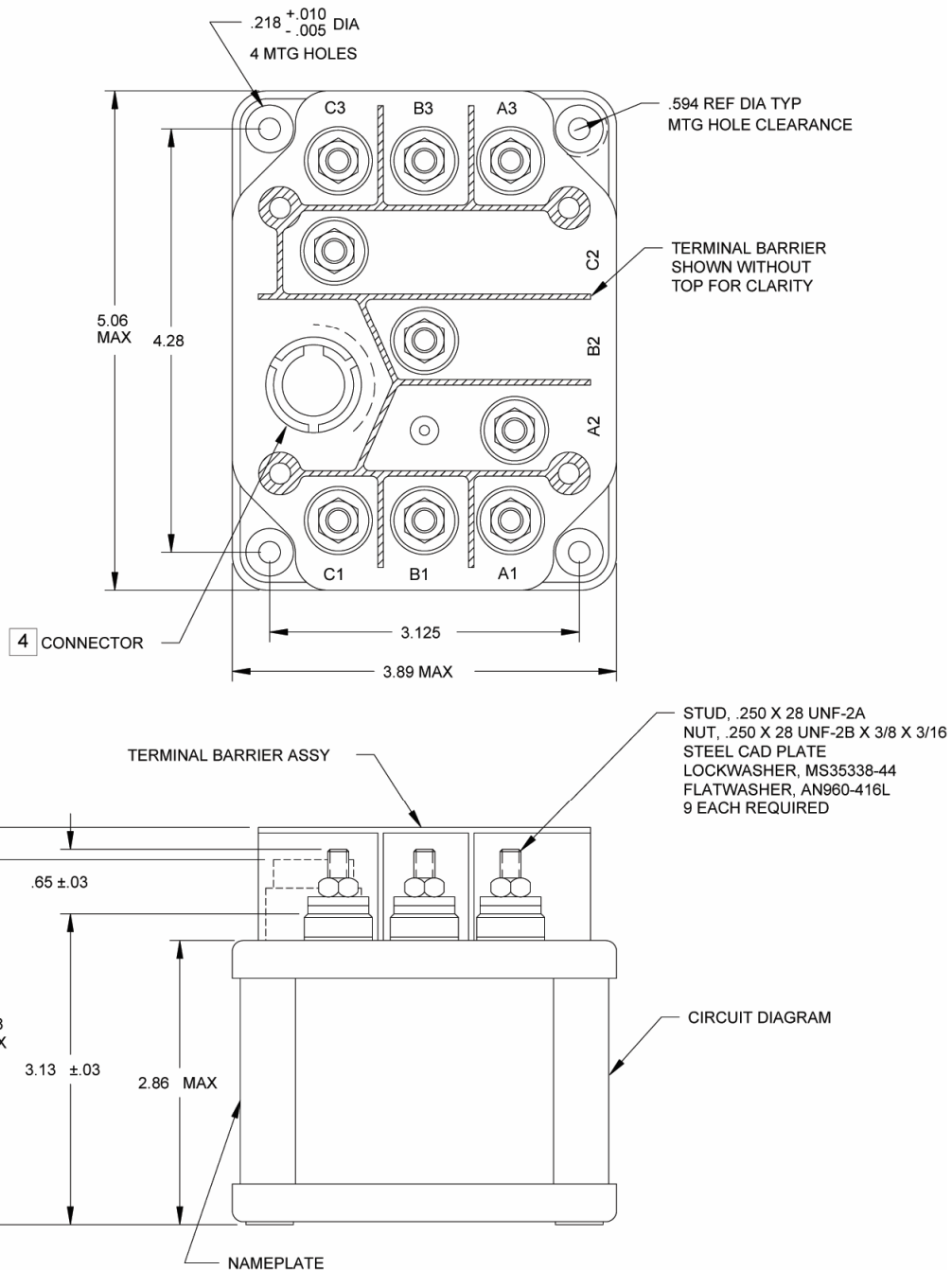

COIL CIRCUIT CONFIGURATION 3

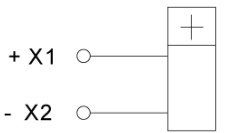

STANDARD
"A, B, C & F" COIL

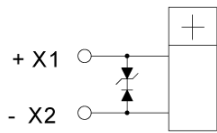

STANDARD WITH
COIL SUPPRESSION
"N" COIL

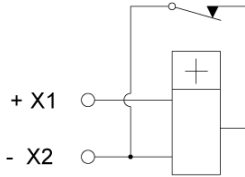

ECONOMIZER COIL
"Y" COIL

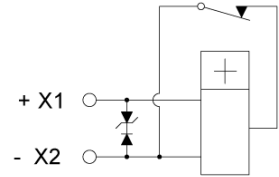

ECONOMIZER COIL WITH
COIL SUPPRESSION
"YN" COIL

TERMINAL CONFIGURATION AND CIRCUIT DIAGRAMS

TERMINAL TYPE 1

3 PDT

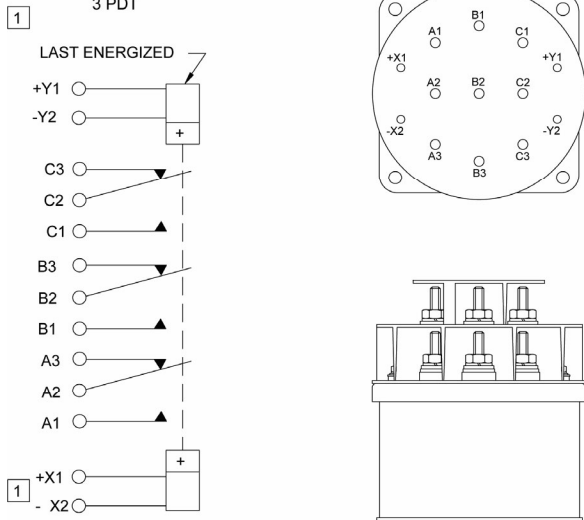

MOUNTING STYLE A ONLY

TERMINAL TYPE 2

3 PST-N.O.

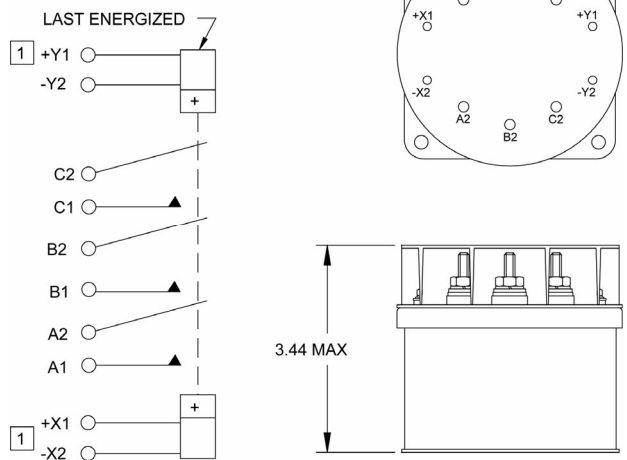

MOUNTING STYLE A ONLY

TERMINAL TYPE 3

3 PST-N.O. WITH
SPST-N.O. & SPST-N.C.
AUXILIARY CONTACTS

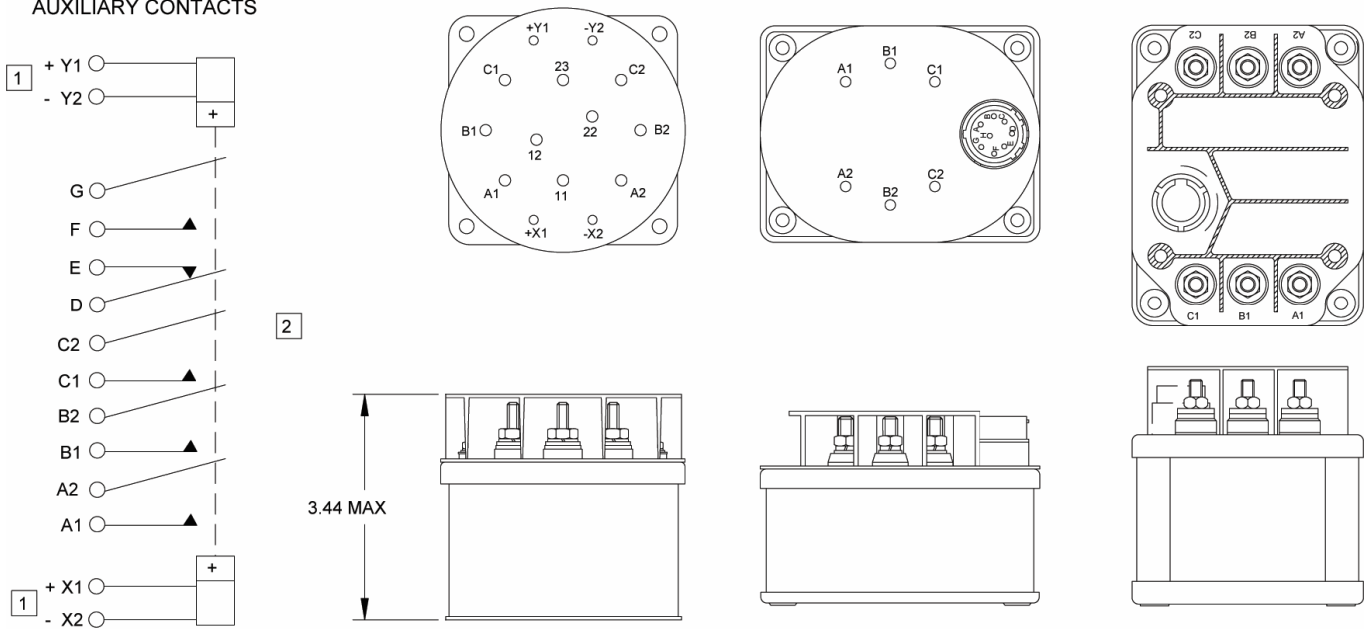

MOUNTING STYLE A

MOUNTING STYLE B

MOUNTING STYLE K

TERMINAL CONFIGURATION AND CIRCUIT DIAGRAMS

TERMINAL TYPE 4

3 PDT-WITH SPST-N.O.
AUXILIARY CONTACTS

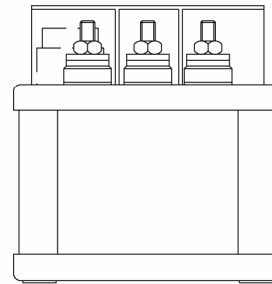
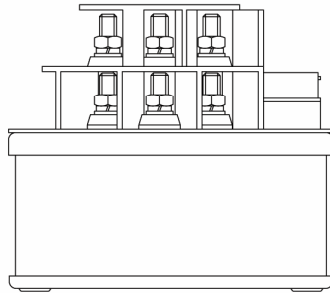
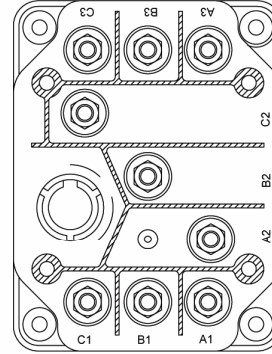
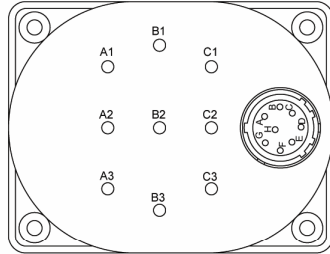
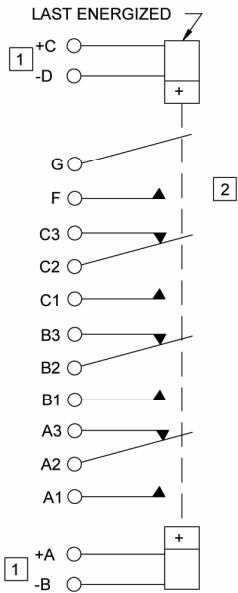

MOUNTING STYLE B

MOUNTING STYLE K

TERMINAL TYPE 5

FOR MOUNTING
STYLE "B" & "K"

3 PDT WITH SPST-N.C.
AUXILIARY CONTACTS

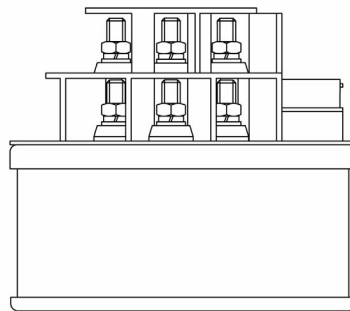
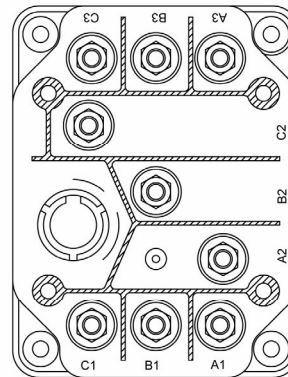
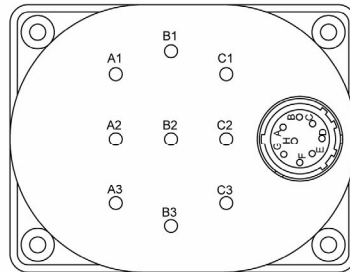
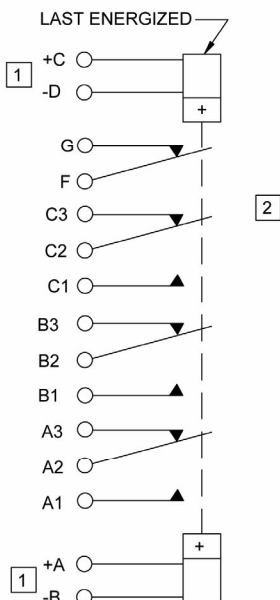

MOUNTING STYLE B

MOUNTING STYLE K

TERMINAL CONFIGURATION AND CIRCUIT DIAGRAMS

TERMINAL TYPE 6

SPDT- DOUBLE BREAK
WITH SPST-N.O. & SPST-N.C.
AUXILIARY CONTACTS

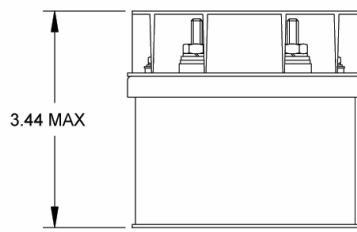
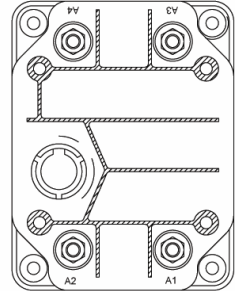
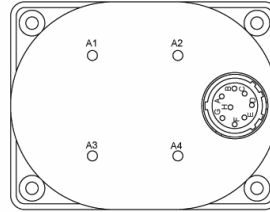
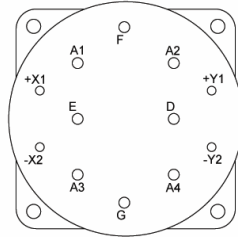
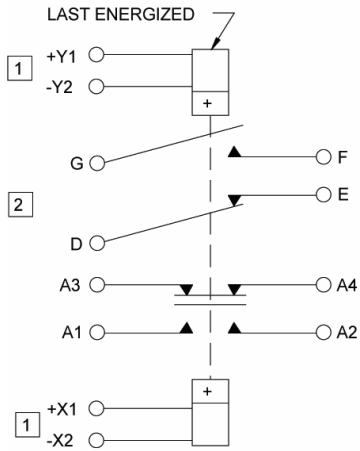

MOUNTING STYLE A

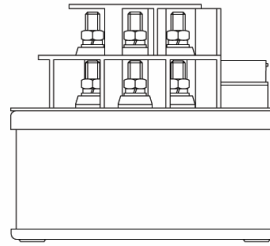

MOUNTING STYLE B



MOUNTING STYLE K

TERMINAL TYPE 7

3 PDT WITH 2 PDT
AUXILIARY CONTACTS

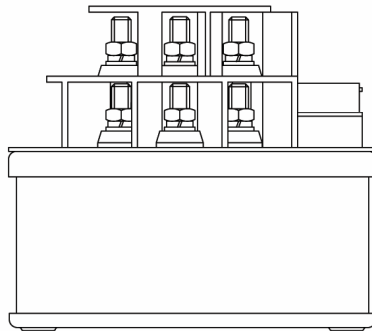
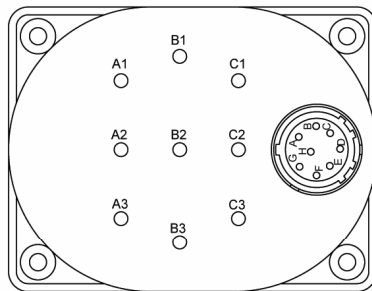
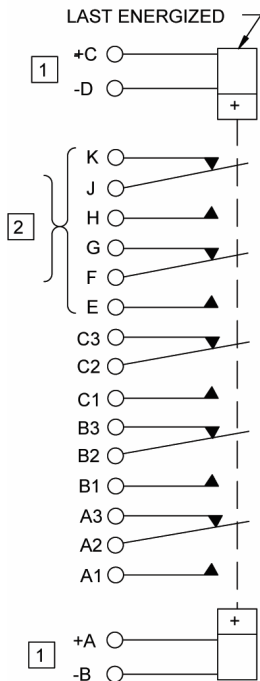

MOUNTING STYLE B

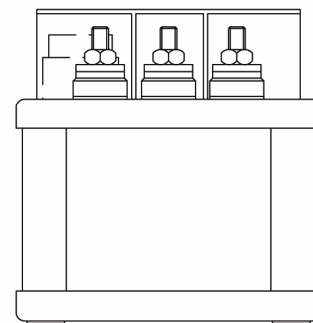
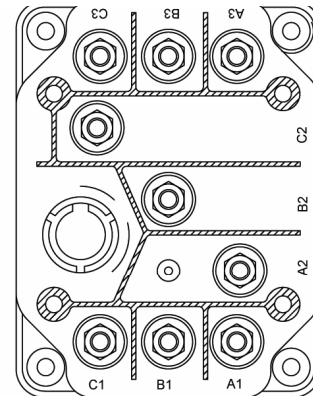

MOUNTING STYLE K

TERMINAL CONFIGURATION AND CIRCUIT DIAGRAMS

TERMINAL TYPE 8

3 PDT WITH 4 PDT
AUXILIARY CONTACTS

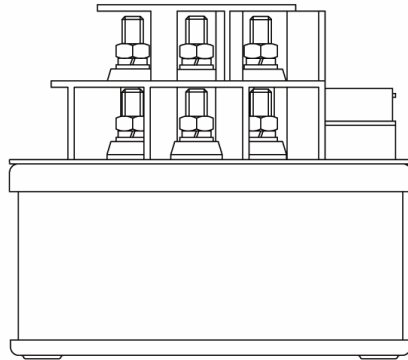
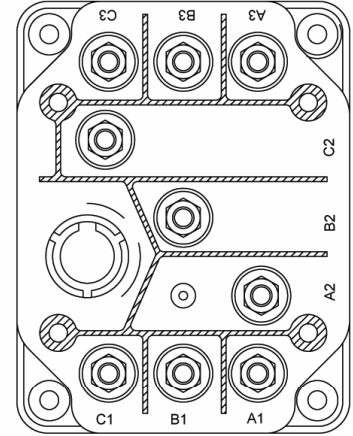
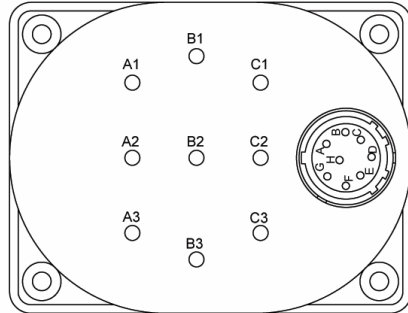
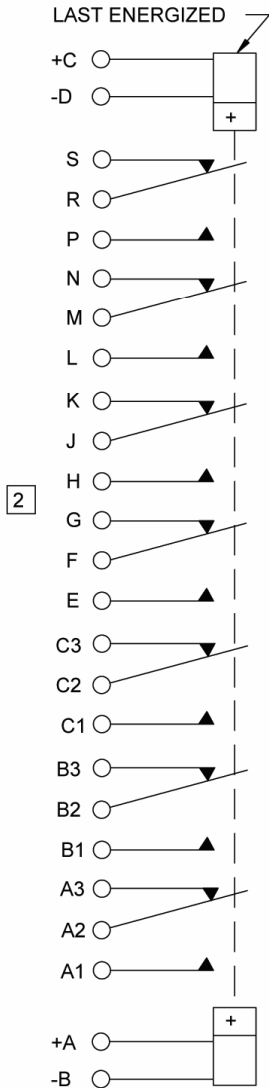

MOUNTING STYLE B

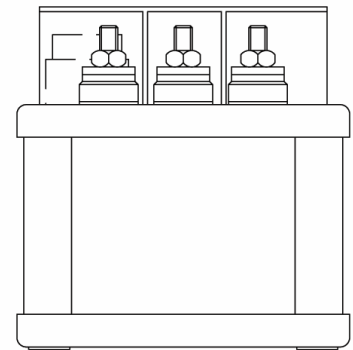

MOUNTING STYLE K

1 POLARITY INDICATION APPLIES TO D.C. COILS ONLY

2 AUXILIARY CONTACT RATING 28 VDC OR 115 VAC

RESISTIVE 5 AMP

INDUCTIVE 3 AMP

LAMP 1 AMP

BOUNCE AT NOMINAL VOLTAGE .004 SEC MAX

3 COIL TERMINALS MAY BE IDENTIFIED AS
A-B, X1-X2, Y1-Y2 OR X-Y.

OTHER AUXILIARY CONTACT FORMS AVAILABLE.
PLEASE CONTACT FACTORY.

4 CIRCULAR CONNECTOR MS-STYLE OR EQUIVALENT

TERMINAL TYPE 9

IS A GENERAL CATEGORY USED FOR ALL TERMINAL TYPES NOT ILLUSTRATED. FOR OTHER VARIATIONS OF TERMINAL CONFIGURATIONS, PLEASE CONTACT FACTORY

NOTE: Although all configuration and/or terminal type options are available, some combinations may require a setup charge and be subject to minimum order size.

NUMBERING SYSTEM

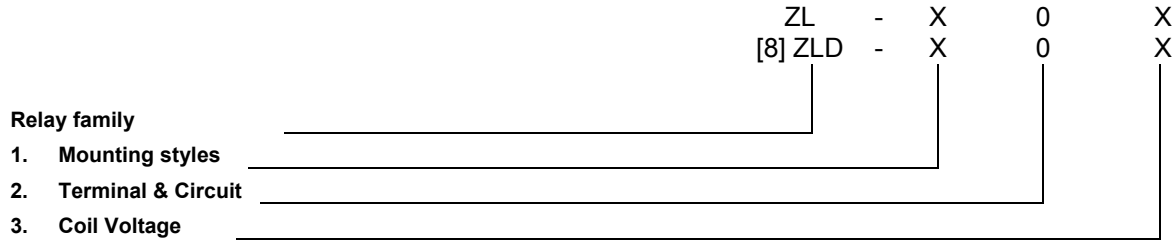

NOTES

1. Inductive load life, 20,000 cycles.
2. Terminal strength per para. 3,4,8,2,1 of MIL-R-6106.
3. Alternate contact configurations and other special models available upon request; Please contact factory.
4. Ratings are for double break/make terminal type 6.
5. Back EMF suppression to 62 Volts max. Consult factory.
6. Suitable for transfer between unsynchronized AC power sources at rating shown.
7. Economizer coils have a lower resistance primary coil for faster operate time. Once relay operates, the coil switches to a higher resistance for lower power drain. Do not ramp up voltage on these coils.
8. Non hermetic gasket sealed version.
9. Available - 200 Amps resistive, 25,000 cycles only, terminal style 6.

For any inquiries, please contact your local sales representative: leachcorp.com